

INSTALLATION AND USER MANUAL

for your heat pump

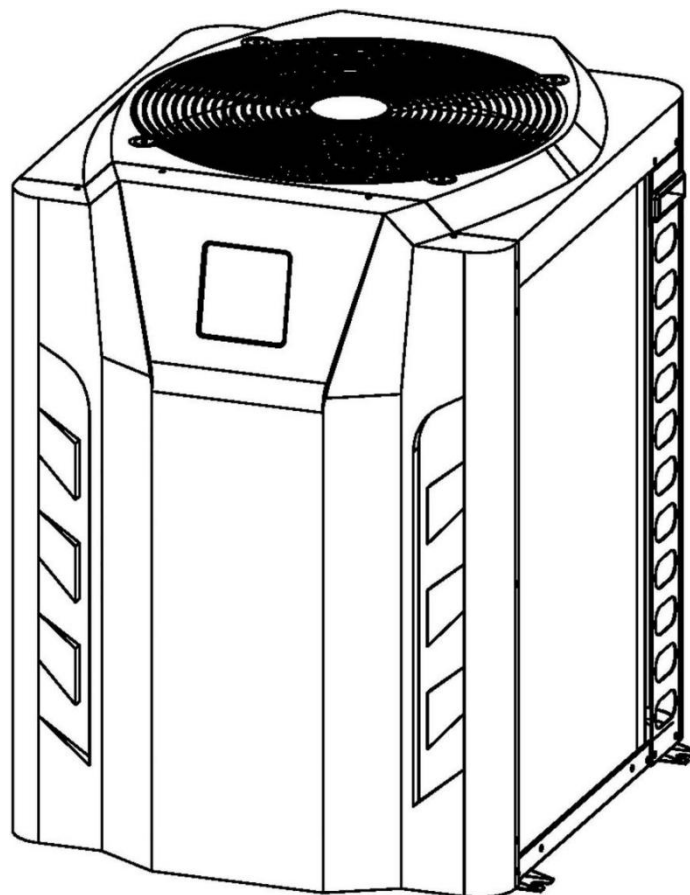

Crystal Vertical 120 / 200



This heat pump contains a flammable refrigerant R32.

Any intervention on the refrigerant circuit is prohibited without a valid authorization.

Before working on the refrigerant circuit, the following precautions are necessary for safe work.

1. Work procedure

The work must be carried out according to a controlled procedure, in order to minimize the risk of presence of flammable gases or vapors during the execution of the works.

2. General work area

All persons in the area must be informed of the nature of the work in progress. Avoid working in a confined area. The area around the work area should be divided, secured and special attention should be paid to nearby sources of flame or heat.

3. Verification of the presence of refrigerant

The area should be checked with a suitable refrigerant detector before and during work to ensure that there is no potentially flammable gas. Make sure that the leak detection equipment used is suitable for flammable refrigerants, is it does not produce sparks, is properly sealed or has internal safety.

4. Presence of fire extinguisher

If hot work is to be performed on the refrigeration equipment or any associated part, appropriate fire extinguishing equipment must be available. Install a dry powder or CO₂ fire extinguisher near the work area.

5. No source of flame, heat or spark

It is totally forbidden to use a source of heat, flame or spark in the direct vicinity of one or more parts or pipes containing or having contained a flammable refrigerant. All sources of ignition, including smoking, must be sufficiently far from the place of installation, repair, removal and disposal, during which time a flammable refrigerant may be released into the surrounding area. Before starting work, the environment of the equipment should be checked to ensure that there is no risk of flammability. «No smoking» signs must be posted.

6. Ventilated area

Make sure the area is in the open air or is properly ventilated before working on the system or performing hot work. Some ventilation must be maintained during the duration of the work.

7. Controls of refrigeration equipment

When electrical components are replaced, they must be suitable for the intended purpose and the appropriate specifications. Only the parts of the manufacturer can be used. If in doubt, consult the technical service of the manufacturer.

The following controls should be applied to installations using flammable refrigerants:

- a. The size of the load is in accordance with the size of the room in which the rooms containing the refrigerant are installed;
- b. Ventilation and air vents work properly and are not obstructed;
- c. If an indirect refrigeration circuit is used, the secondary circuit must also be checked.
- d. The marking on the equipment remains visible and legible. Illegible marks and signs must be corrected.
- e. Refrigeration pipes or components are installed in a position where they are unlikely to be exposed to a substance that could corrode components containing refrigerant.

8. Verification of electrical appliances

Repair and maintenance of electrical components must include initial safety checks and component inspection procedures. If there is a defect that could compromise safety, no power supply should be connected to the circuit until the problem is resolved.

Initial security checks must include:

- a. That the capacitors are discharged: this must be done in a safe way to avoid the possibility of sparks;
- b. No electrical components or wiring are exposed during loading, recovery or purging of the refrigerant gas system;
- c. There is continuity of grounding.

These installation instructions are an integral part of the product.

They must be given to the installer and retained by the user.

If the manual is lost, please consult the website:

The instructions and recommendations contained in this manual should be read carefully and understood since they provide valuable information concerning the heat pump's safe handling and operation. **Keep this manual in an accessible place for easy future reference.**

Installation must be carried out by a qualified professional person in accordance with current regulations and the manufacturer's instructions. An installation error may cause physical injury to persons or animals as well as mechanical damage for which the manufacturer can under no circumstances be held responsible.

After unpacking the heat pump, please check the contents in order to report any damage. Please also check that the pressure indicated on the gauge is higher than 80 psi. If not, this could mean a leak of refrigerant.

Prior to connecting the heat pump, ensure that the information provided in this manual is compatible with the actual installation conditions and does not exceed the maximum limits authorised for this particular product.

In the event of a defect and/or malfunction of the heat pump, the electricity supply must be disconnected and no attempt made to repair the fault.

Repairs must be undertaken only by an authorised technical service organization using original replacement parts. Failure to comply with the above-mentioned clauses may have an adverse effect on the heat pump's safe operation.

To guarantee the heat pump's efficiency and satisfactory operation, it is important to ensure its regular maintenance in accordance with the instructions provided.

If the heat pump is sold or transferred, always make sure that all technical documentation is transmitted with the equipment to the new owner.

This heat pump is designed solely for heating a swimming pool. Any other use must be considered as being inappropriate, incorrect or even hazardous.

Any contractual or non-contractual liability of the manufacturer/distributor shall be deemed null and void for damage caused by installation or operational errors, or due to non-compliance with the instructions provided in this manual or with current installation norms applicable to the equipment covered by this document.

Contents

1. General	4
1.1 General Terms of Delivery.....	4
1.2 Safety Instruction.....	4
1.3 Water treatment.....	5
2. Description	6
2.1 Package contents.....	6
2.3 Technical Specification.....	7
2.4 Unit dimension.....	8
2.5 Exploding view.....	9
3. Installation	10
3.1 Pre-requirements.....	10
3.2 Location.....	10
3.3 Installation layout.....	11
3.4 Connecting the condensation draining kit.....	11
3.5 Installing the unit on noise-damping supports.....	11
3.6 Hydraulic connection.....	12
3.7 Electrical installation.....	14
3.8 Electrical connection.....	15
4. Use	16
4.1 Wired remote control.....	16
4.2 Operating mode selector.....	17
4.3 Setting the clock.....	18
4.4 Programming Start/Stop.....	18
4.5 Activating a program.....	18
4.6 Forced de-icing function.....	19
4.7 Enable / Disable LEDs.....	19
4.8 Status values.....	20
4.9 System parameter query.....	21
5. Operation	23
5.1 Operation.....	23
5.2 Using the pressure gauge.....	24
6. Maintenance and servicing	25
6.1 Maintenance and servicing.....	25
6.2 Winter storage.....	26
7. Repairs	27
7.1 Breakdowns and faults.....	27
7.2 List of faults.....	28
8. Wiring diagram	29

1. General

1.1 General Terms of Delivery

All equipment, even if shipped 'free of carriage and packing', is dispatched at the consignee's own risk

The person responsible for receiving the equipment must carry out a visual inspection to identify any damage to the heat pump during transport (refrigerant system, body panels, electrical control box, frame). He/ she must note down on the carrier's delivery note any remarks concerning damage caused during transport and confirm them to the carrier by registered letter within 48 hours.

The equipment must always be stored and transported vertically on a pallet and in its original packaging. If it is stored or transported horizontally, wait at least 24 hours before switching it on.

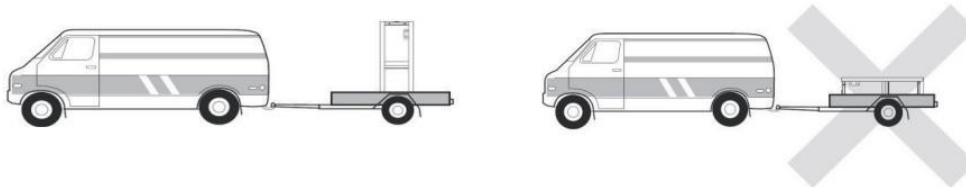

1.2 Safety Instruction



WARNING: Please read carefully the safety instructions before using the equipment. The following instructions are essential for safety so please strictly comply with them.

During installation and servicing

Only a qualified person may undertake installation, start-up, servicing and repairs, in compliance with current standards.

Before operating or undertaking any work on the equipment (installation, commissioning, usage, servicing), the person responsible must be aware of all the instructions in the heat pump's installation manual as well as the technical specifications.

Under no circumstances install the equipment close to a source of heat, combustible materials or a building's air intake.

If installation is not in a location with restricted access, a heat pump protective grille must be fitted.

To avoid severe burns, do not walk on pipe work during installation, repairs or maintenance.

To avoid severe burns, prior to any work on the refrigerant system, turn off the heat pump and wait several minutes before placing temperature and pressure sensors. Check the refrigerant level when servicing the heat pump.

Check that the high and low pressure switches are correctly connected to the refrigerant system and that they turn off the electrical circuit if tripped during the equipment's annual leakage inspection.

Check that there is no trace of corrosion or oil stains around the refrigerant components.

During use

To avoid serious injuries, never touch the fan when it is operating.

Keep the heat pump out of the reach of children to avoid serious injuries caused by the heat exchanger's blades.

Never start the equipment if there is no water in the pool or if the circulating pump is stopped.

Check the water flow rate every month and clean the filter if necessary.

During cleaning

Switch off the equipment's electricity supply.

Close the water inlet and outlet valves.

Do not insert anything into the air or water intakes or outlets. Do not rinse the equipment with water.

During repairs

Carry out work on the refrigerant system in accordance with current safety regulations.

Brazing should be performed by a qualified welder.

When replacing a defective refrigerant component, use only parts certified by our technical department.

When replacing pipe work, only copper pipes conforming to Standard NF EN12735-1 may be used for repairs.

When pressure-testing to detect leaks:

To avoid the risks of fire or explosion, never use oxygen or dry air. Use dehydrated nitrogen or a mixture of nitrogen and refrigerant. The low and high side test pressure must not exceed 42 bar.

1.3 Water treatment

Heat pumps for swimming pools can be used with all types of water treatment systems.

Nevertheless, it is essential that the treatment system (chlorine, pH, bromine and/or salt chlorinator metering pumps) is installed after the heat pump in the hydraulic circuit.

To avoid any deterioration to the heat pump, the water's pH must be maintained between 6.9 and 8.0.

2. Description

2.1 Package contents

- √ Heat pump
- √ 2 hydraulic inlet/outlet connectors (48/50mm diameter)
- √ This installation and user manual
- √ Condensation draining kit
- √ 4 anti-vibration pads (fastenings not supplied)

2.2 General characteristics

A heat pump has the following features:

- √ CE certification and complies with the RoHS European directive.
- √ High performance with up to 90% energy savings compared to a conventional heating system.
- √ Clean, efficient and environmentally friendly R32 refrigerant.
- √ Reliable high output leading brand compressor.
- √ Wide hydrophilic aluminium evaporator for use at low temperatures. User-friendly intuitive remote control.
- √ Heavy duty ABS shell, anti-UV treated and easy to maintain. Designed to be silent.
- √ Dual antifreeze system to avoid frost damage:
Revolutionary exchanger with patented antifreeze system.
A smart monitoring system to preserve the pipe work and liner without emptying the pool in winter.

2.3 Technical Specification

			Crystal Vertical	Crystal Vertical
Ambient		15°C	120	200
Advised pool volume		m³	35-50	60-80
Heating temperature range		°C	25~40	25~40
Cooling temperature range		°C	8~28	8~28
Auto mode temperature range		°C	5~43	5~43
Operating range		°C	-20~43	-20~43
Air 26°C	Water 26°C Inverter mode	Capacity(KW)	13.00~3.04	20.93~5.23
		Power input(KW)	1.94~0.24	3.22~0.46
		Input current(A)	8.61~1.06	14.29~2.04
		COP	12.67~6.70	11.37~6.50
Air 26°C	Water 26°C Silent mode	Capacity(KW)	9.39~3.04	14.65~5.23
		Power input(KW)	1.33~0.24	1.77~0.46
		COP	12.67~7.06	11.37~8.29
Air 15°C	Water 26°C Inverter mode	Capacity(KW)	9.63~2.23	15.50~3.88
		Power input(KW)	2.10~0.32	3.39~0.57
		Input current(A)	9.41~1.43	15.04~2.53
		COP	6.96~4.59	6.80~4.57
Air 15°C	Water 26°C Silent mode	Capacity(KW)	6.74~2.23	10.85~3.88
		Power input(KW)	1.25~0.32	1.86~0.57
		COP	6.96~5.39	6.80~5.83
Air 35°C	Water 27°C	Capacity(KW)	7.25~2.93	10.85~5.03
		Power input(KW)	2.04~0.63	2.58~1.05
		Input current(A)	8.96~2.77	11.33~4.61
		EER	4.65~3.55	4.77~3.56
Air -15°C	Water 26°C	Capacity(KW)	4.33~1.00	6.95~1.75
		Power input(KW)	1.995~0.304	3.221~0.542
		Input current(A)	8.652~1.322	14.00~2.357
		COP	3.29~2.17	3.23~2.17
Air -20°C	Water 26°C	Capacity(KW)	2.41~0.56	3.88~0.97
		Power input(KW)	1.89~0.288	3.051~0.513
		Input current(A)	8.217~1.252	13.261~2.230
		COP	1.94~1.28	1.89~1.27
Power supply			220-240V~ /50Hz	
Max power input		KW	2.8	3.8
Rated current(Air 15°C/Water 26°C)		A	9.41~1.43	15.04~2.53
Max Current (correct)		A	12.42	16.86
Water flow		m³/h	3.8	6.7
Refrigerant			R32	R32
Min pressure/max pressure			1.5/4.15MPa	1.5/4.15MPa
Unit net dimensions		mm	540*600*735	540*600*735
Package dimensions		mm	976*665*865	576*685*865
Net weight		kg	45	52
Gross weight		kg	53	60
Noise at 1 m		dB(A)	40~48	42~52
Noise at 10m		dB(A)	21~29	24~32
compressor brand			GMCC	GMCC
compressor type			Twin-Rotary	Twin-Rotary
water proof level			IPX4	IPX4
Loss charge		(mCE)	1.1	1.1

Note: marked * specification only applicable to low temperature model.

2.4 Unit dimension

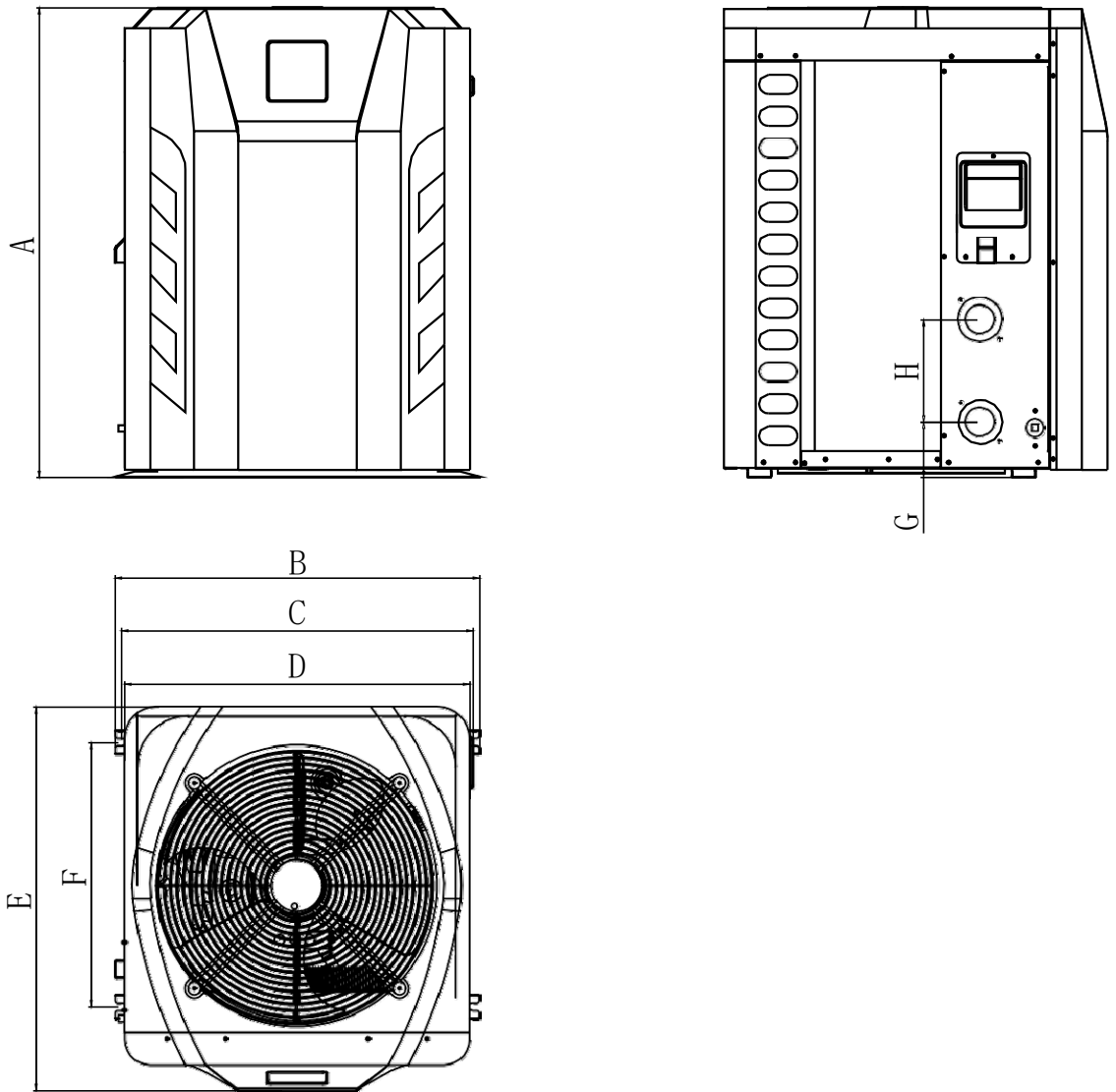

	Crystal Vertical	Crystal Vertical
	120	200
A	735	735
B	570	570
C	550	550
D	540	540
E	600	600
F	414	414
G	87	87
H	160	160

Made in mm

2.5 Exploding view

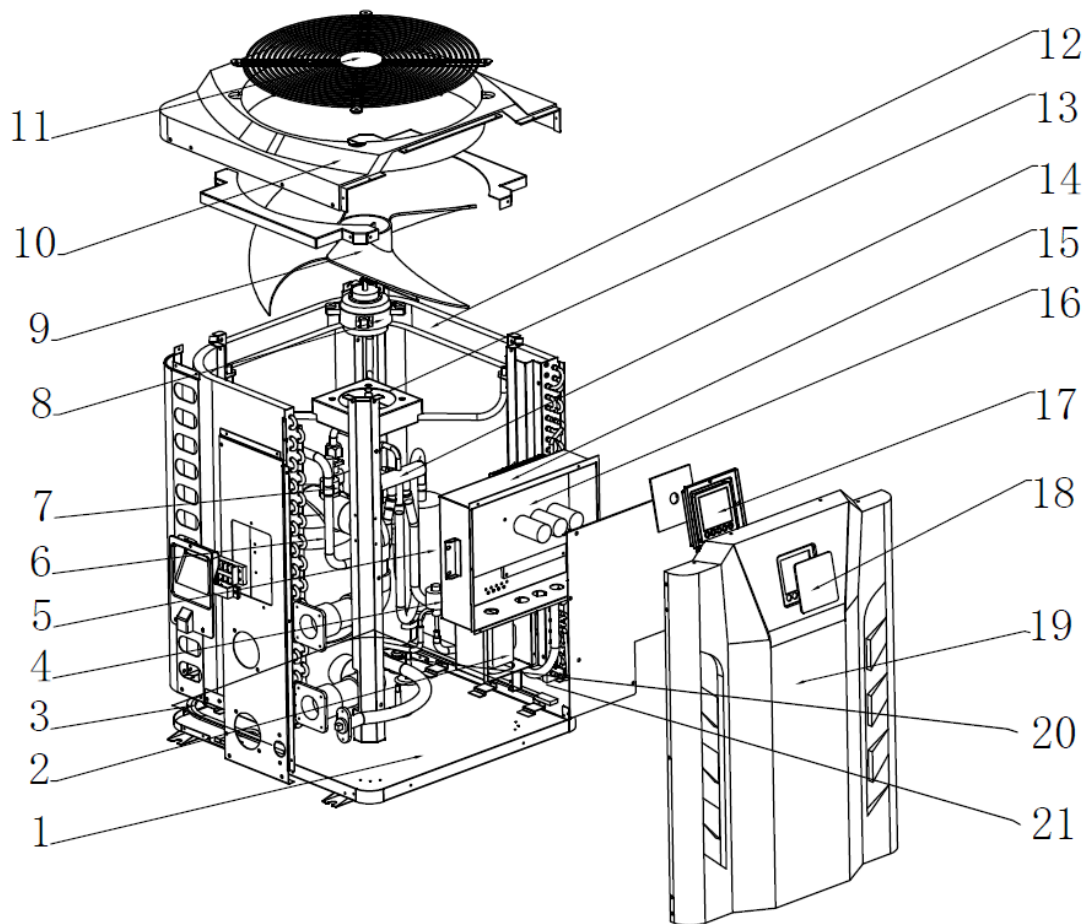

1	Base Frame	12	Evaporator
2	Electric Reactor	13	Motor Bracket
3	Tray Heating Belt	14	4-way valve
4	Electronic Expansive Valve	15	Electrical Control Box
5	Compressor	16	Controller
6	Heat Exchanger	17	Control Panel
7	Water Flow Switch	18	Display Panel
8	Fan Motor	19	Front Panel
9	Fan Blade	20	Electric crankshaft heating
10	Top Cover	21	Electric base frame heating
11	Air Outlet Net		

3. Installation



WARNING: Installation must be carried out by a qualified engineer.

This section is provided for information purposes only and must be checked and adapted if necessary according to the actual installation conditions.

3.1 Pre-requirements

Equipment necessary for the installation of your heat pump:

Power supply cable suitable for the unit's power requirements.

A By-Pass kit and an assembly of PVC tubing suitable for your installation as well as stripper, PVC adhesive.

A set of wall plugs and expansion screws suitable to attach the unit to your support.

Suitable fastening studs may be used to raise the unit.

3.2 Location

Please comply with the following rules concerning the choice of heat pump location.

- The unit's future location must be easily accessible for convenient operation and maintenance.
- It must be installed on the ground, fixed ideally on a level concrete floor. Ensure that the floor is sufficiently stable and can support the weight of the unit.
- A water drainage device must be provided close to the unit in order to protect the area where it is installed.
- If necessary, the unit may be raised by using suitable mounting pads designed to support its weight.
- Check that the unit is properly ventilated, that the air outlet is not facing the windows of neighbouring buildings and that the exhaust air cannot return. In addition, provide sufficient space around the unit for servicing and maintenance operations.
- The unit must not be installed in an area exposed to oil, flammable gases, corrosive products, sulphurous compounds or close to high frequency equipment.
- To prevent mud splashes, do not install the unit near a road or track.
- To avoid causing nuisance to neighbours, make sure the unit is installed so that it is positioned towards the area that is least sensitive to noise.
- Keep the unit as much as possible out of the reach of children.

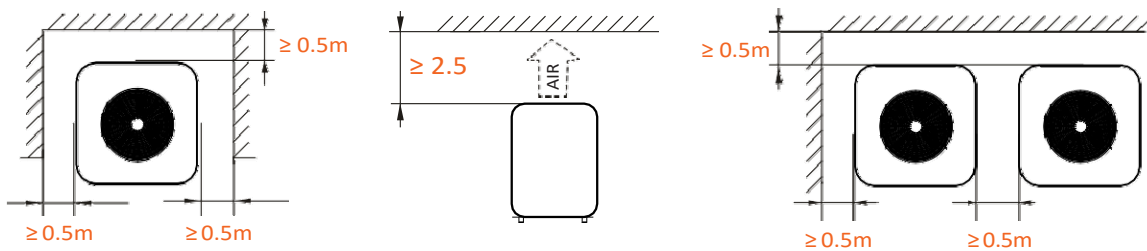

Dimensions in mm.

Place nothing less than one metre in front of the heat pump.

Leave 50 cm of empty space around the sides and rear of the heat pump.

Do not leave any obstacle above or in front of the unit!

3.3 Installation layout

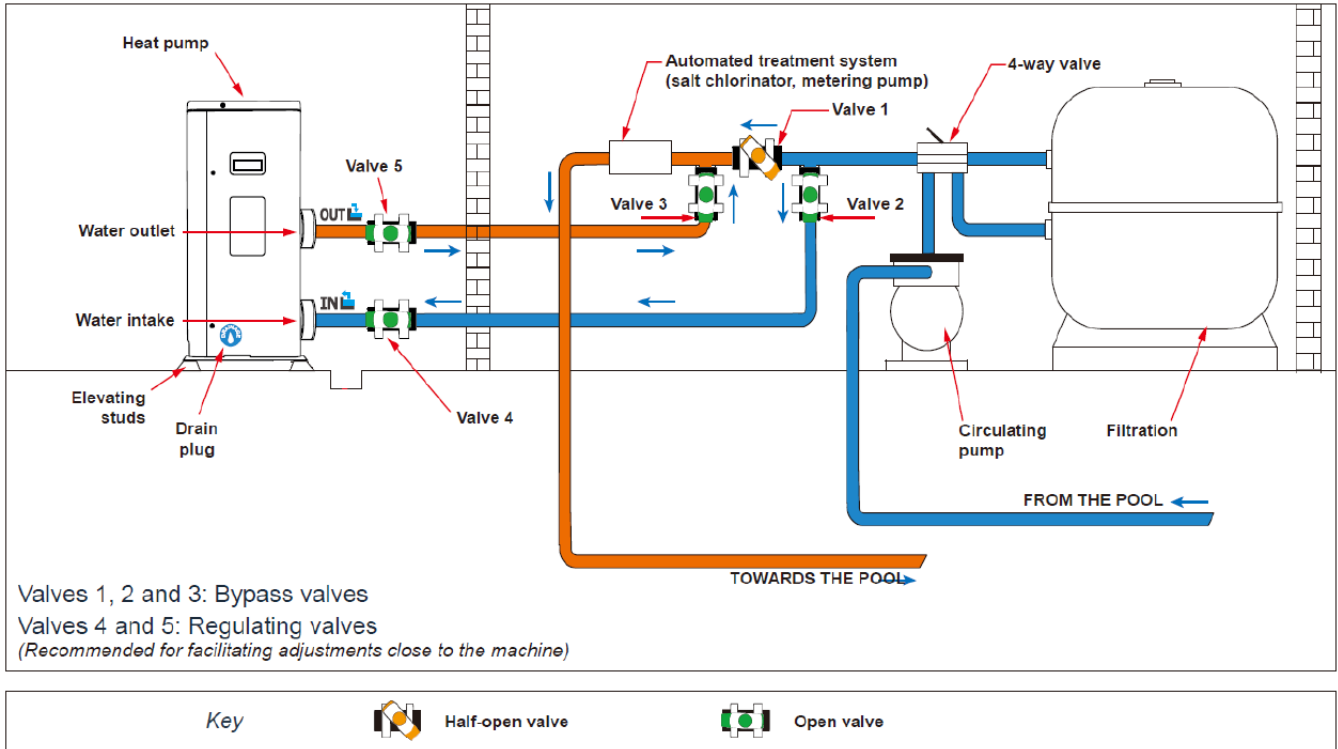

3.4 Installing the unit

While operating, the heat pump is subject to condensation. This will result in a more or less large run-off of water, depending on the degree of humidity.

Install the heat pump, raising it at least 10 cm with solid water-resistant pads, then connect the drainage pipe to the opening located under the pump.

***IN Winter USE* - DO NOT Connect the drainage pipe** when using the heat pump in the **winter**, as this will allow the water to freeze and block the tube. This will then allow water and ice to back up into the unit and cause damage which will not be covered under the **Warranty**.

Please allow unrestricted run off of the condensate from the unit and to escape freely.

3.5 Installing the unit on noise-damping supports

In order to minimize the noise pollution associated with heat pump vibrations, it can be positioned on vibration absorbing pads.

To do this, you simply have to position a pad between each of the unit's feet and its support, and then fix the heat pump to the support with suitable screws.

WARNING: Installation must be carried out by a qualified engineer.



This section is provided for information purposes only and must be checked and adapted if necessary according to the actual installation conditions.

3.6 Hydraulic connection

By-Pass assembly

The heat pump must be connected to the pool by means of a By-Pass assembly.

A By-Pass is an assembly consisting of 3 valves that regulate the flow circulating in the heat pump.

During maintenance operations, the By-Pass permits the heat pump to be isolated from the system without interrupting your installation.

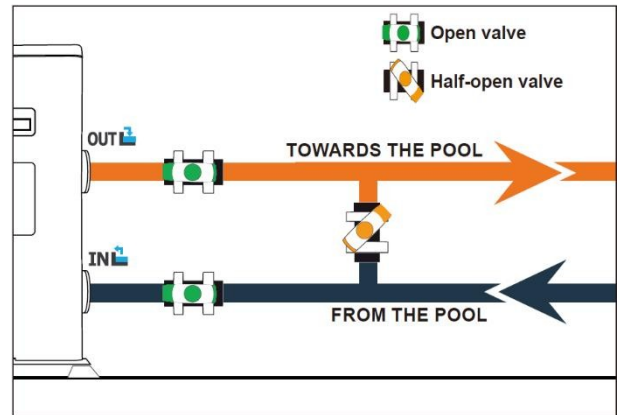

Making a hydraulic connection with the By-Pass kit

WARNING: Do not run water through the hydraulic circuit for 2 hours after applying the adhesive.

Step 1: Take the necessary steps to cut your pipes.

Step 2: Make a straight perpendicular cut through the PVC pipes with a saw.

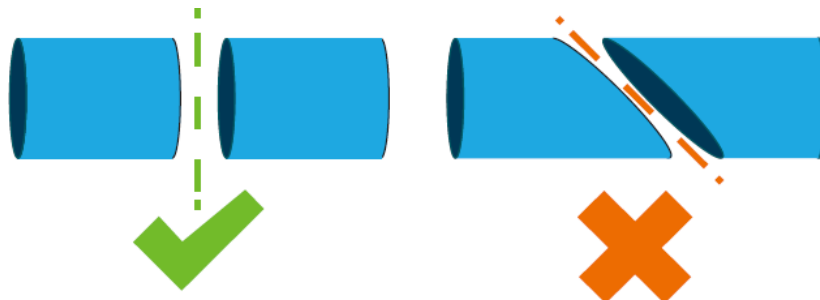

Step 3: Assemble your hydraulic circuit without connecting it in order to check that it perfectly fits your installation, then dismantle the pipes to be connected.

Step 4: Chamfer the ends of the cut pipes.

Step 5: Apply pipe and connections cleaner to the ends of the pipes and fittings, to be connected so both are cleaned before gluing.

Step 6: Apply the adhesive in the same place.

Step 7: Assemble the pipe and fittings.

Step 8: Clean off any adhesive remaining on the PVC.

Step 9: Leave to dry for at least 2 hours before putting the hydraulic circuit into water.

By-Pass assembly for one heat pump

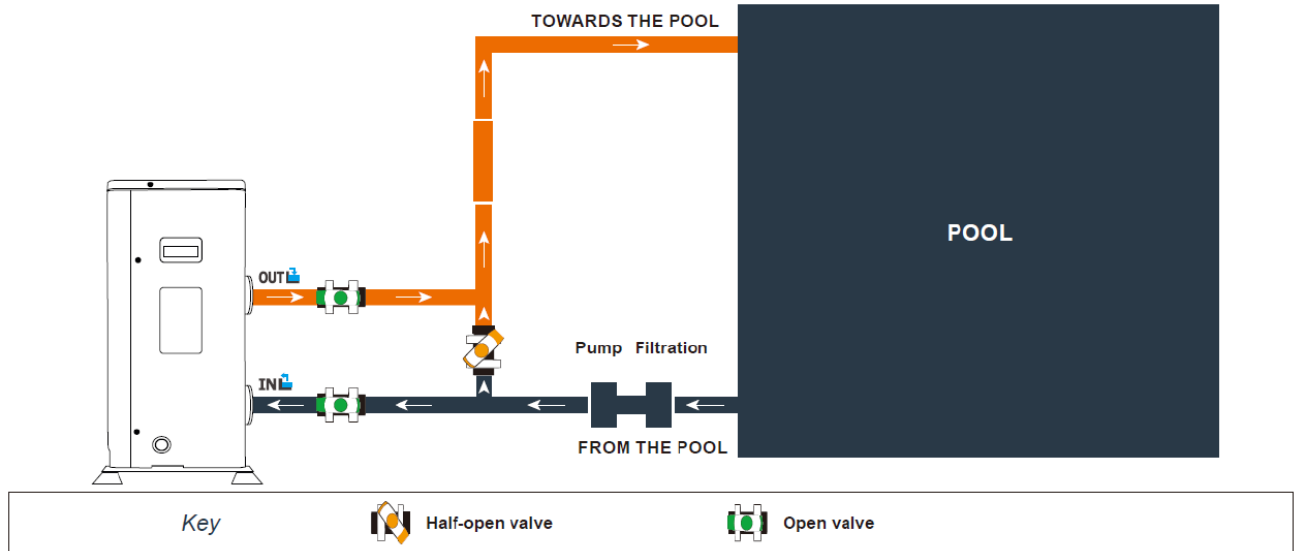

By-Pass assembly for more than one heat pump

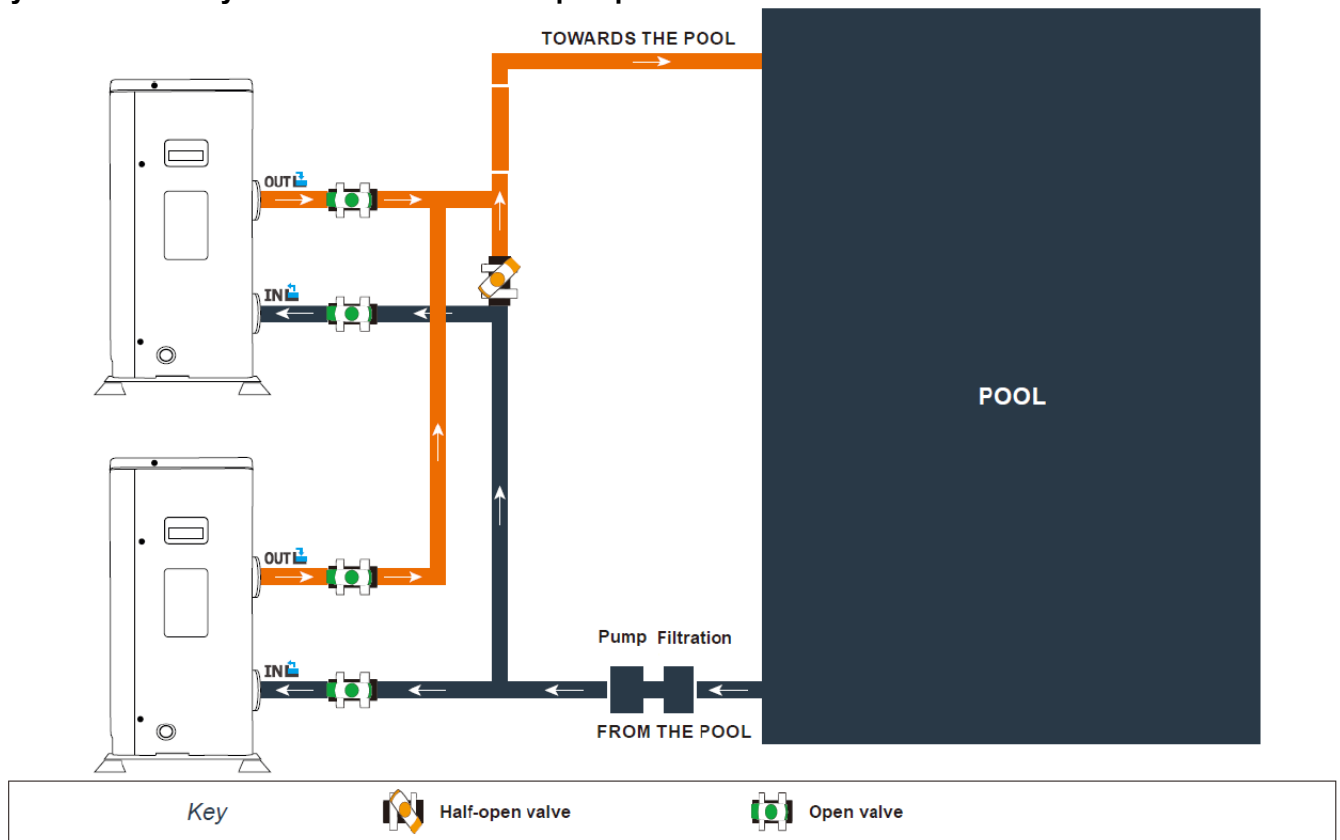

The filter located downstream of the heat pump must be regularly cleared so that the water in the system is clean, thus avoiding the operational problems associated with dirt or clogging in the filter.

WARNING: Installation must be carried out by a qualified engineer.



This section is provided for information purposes only and must be checked and adapted if necessary according to the actual installation conditions.

3.7 Electrical installation

To function safely and maintain the integrity of your electrical system, the unit must be connected to a general electricity supply in accordance with the following regulations:

Upstream, the general electricity supply must be protected by a 30 mA differential switch.

The heat pump must be connected to a suitable D-curve circuit breaker (see table below) in accordance with current standards and regulations in the country where the system is installed.

The electricity supply cable must be adapted to match the unit's rated power and the length of wiring required by the installation (see table below). The cable must be suitable for outdoor use.

For a three-phase system, it is essential to connect the phases in the correct sequence. If the phases are inverted, the heat pump's compressor will not work.

In places open to the public, it is mandatory to install an emergency stop button close to the heat pump.

Model	max current (A)	maximum length of the wire (m)				Refrigerant
		2.5mm ²	4mm ²	6mm ²	10mm ²	
Crystal Vertical 120	12.42	47	76	114	198	R32
Crystal Vertical 200	16.86	34	56	84	146	

3.8 Electrical connection

 **WARNING:** The heat pump's power supply **MUST** be disconnected before any operation.

Please comply with the following instructions to electrically connect the heat pump.

Step 1: Detach the electrical side panel with a screwdriver to access the electrical terminal block.

Step 2: Insert the cable into the heat pump unit by passing it through the opening provided for that purpose.

Step 3: Connect the power supply cable to the terminal block in accordance with the diagram below.

Step 4: Carefully close the heat pump panel.

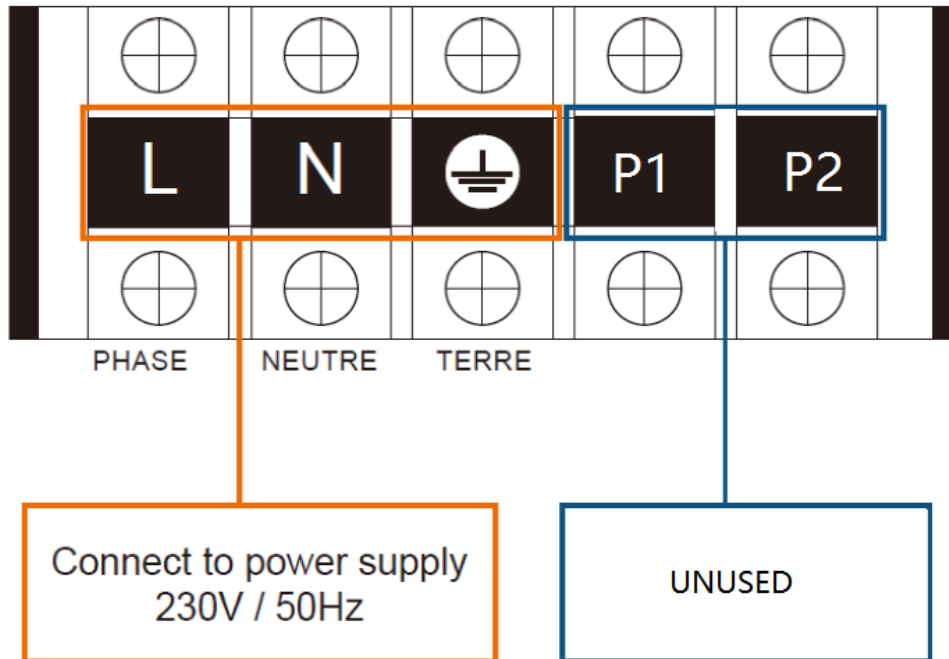

4. Use

4.1 Wired remote control

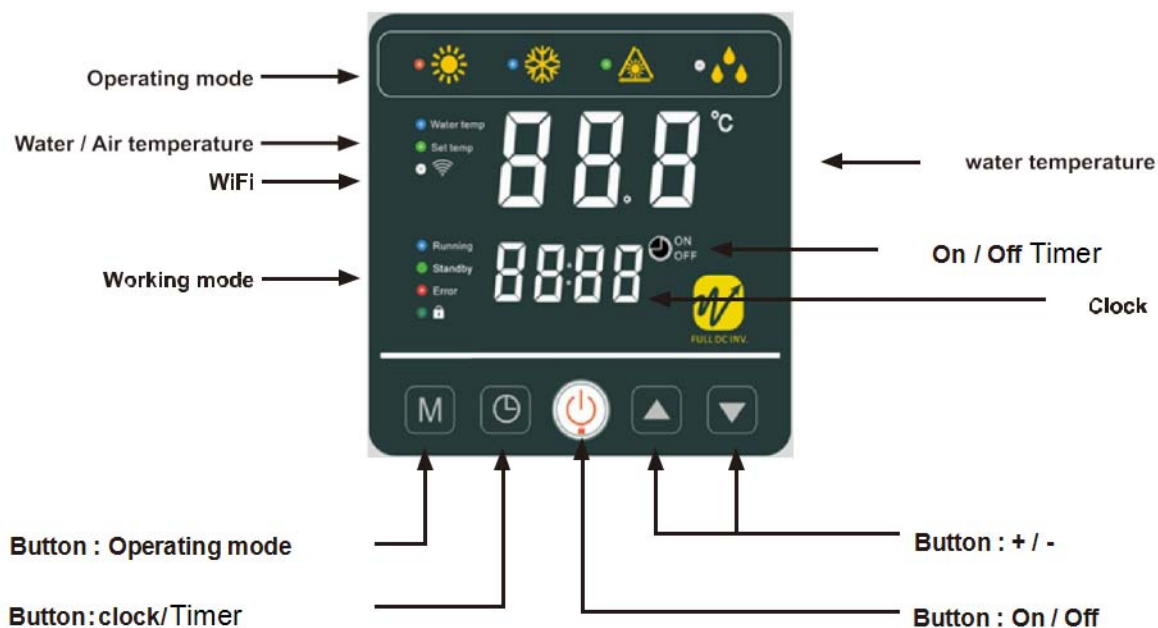

To start the heat pump, press the  button for 3s

Adjusting the water temperature

Once the unit is unlocked, press the  or  buttons to set the desired temperature.

Locking the control panel

To lock or unlock the control panel, press 3s the buttons  and 

4. Use

4.2 Operating mode selector



Before starting, ensure that the filtration pump is working and that water is circulating through the heat pump.

To choose the operating mode, press the **M** button for 3s



Heating Mode (inverter)

Select the heating mode for the heat pump to heat the water in your pool intelligently.



Cooling Mode (inverter)

Select the cooling mode for the heat pump to cool the water in your pool intelligently.



ECO Silence Mode

Select the silence heating mode for the heat pump to heat the water at reduced speed.



defrosting mode

Defrost mode is automatic and is activated when the evaporator has reached a negative temperature.



Auto mode

Automatic cooling or heating according to the set temperature.

Useful information







WARNING: When the cooling mode switches to heating mode or vice-versa, the heat pump will restart after 10 minutes.

When the incoming water temperature is less than or equal to the required temperature (set point temperature -1°C), the heat pump will switch to heating mode. The compressor will stop when the temperature of the incoming water is greater than or equal to the required temperature (set point temperature $+1^{\circ}\text{C}$).

4. Use

4.3 Setting the clock

















Set the system clock to local time, as follows:

- Step 1: Press  to set the time, the hours are blinking.
- Step 2: Adjust the hours with the buttons  and .
- Step 3: Press  to switch to minutes.
- Step 4: Adjust the minutes with the buttons  and .
- Step 5: Press  to validate and return to the main screen.



4.4 Programming Start/Stop





This function is for programming the Start/Stop timing. You can program up to 3 different Start/Stop timings. Setting is as follows:

- Step 1: Long press  3s to enter into timer functions
- Step 2: Select the program to be configured with the buttons  and .
- Step 3: Press  to program the start time.
- Step 4: Adjust the hours with the buttons  and .
- Step 5: Press  to switch to minutes.
- Step 6: Adjust the minutes with the buttons  and .
- Step 7: Press  to program the stop time.
- Step 8: Adjust the hours with the buttons  and .
- Step 9: Press  to switch to minutes.
- Step 10: Adjust the minutes with the buttons  and .
- Step 11: Press  to return to the main screen.

NB: The remote control returns automatically to the main screen after 10 seconds.

4.5 Activating a program

Once the program has been defined, it can be activated as follows:

- Step 1: Long press  3s to enter into timer functions
- Step 2: Select the program to be activated with the buttons  and .
- Step 3: Keep pressing  until the ON/OFF indicator lights are displayed and start flashing.
- Step 4: Press  to return to the main screen.



The flashing ON/OFF lights indicate an active program.

4. Use

4.6 Forced de-icing function

Long  and  3 seconds to enter forced de-icing, the symbol  flashes.

4.7 Enable / Disable LEDs

Hold  and  for 3 seconds to activate or deactivate the front LEDs. The LEDs are reactivated automatically after a power cut.

4. Use

4.8 Status values

The status values can be checked via the remote control by following these steps

Step 1: Keep pressing  until you enter the settings verification mode.

Step 2: Press  and  to check the status values.

Step 3: Press  to return to the main screen.

Status values table

N°	Description	Values
01	Water inlet temperature	-30~99°C
02	Water outlet temperature	-30~99°C
03	Ambient temperature	-30~99°C
04	Air outlet temperature	0~125°C
05	Air inlet temperature	-30~99°C
06	Outside coil temperature	-30~99°C
07	Inside coil temperature	-30~99°C
08	The openness of the expansion valve	
09	Reserved	
10	Compressor current (A)	
11	PCB temperature (°C)	
12	Fan motor current (A)	
13	Compressor real frequency (Hz)	
14	Main PCB current (A)	
15	Fan motor speed (RPS)	0~2500, Real=display value*2

4. Use

4.9 System parameter query



WARNING : This operation is used to assist servicing and future repairs.



The default settings should only be modified by an experienced professional person.



WARNING : Any change to the reserved settings will automatically void the warranty.

The system's settings can be checked and adjusted via the remote control by following these steps

Step 1 : Keep pressing 3s on  until you enter the settings verification mode.

Step 2 : Press  and  for see the configured parameters.

Step 3 : Press  to select the setting to be modified, the value is blinking.

Step 4 : Press  and  to adjust the setting value.

Step 5 : Press  to set the new value.

Step 6 : Press  to return to the main screen.

If not operation for 10s, it will be exited automatically.

Parameters table

N°	Description	Adjustment range	Factory setting	Remarks
01*	Adjustment of temperature difference before restart	1~18°C	1°C	Adjustable
02	Reserved - Do not adjust			Reserved
03	Reserved - Do not adjust			Reserved
04	Adjusting the cooling temperature	8~28°C	27°C	Adjustable
05	Adjusting the heating temperature	15~40°C	27°C	Adjustable
06	Reserved - Do not adjust			Reserved
07	Reserved - Do not adjust			Reserved
08	Reserved - Do not adjust			Reserved
09	Setting the compensation coefficient of the temperature water inlet	-5~15°C	0°C	Adjustable
10	Reserved - Do not adjust			Reserved
11	Auto-activation time before de-icing commences	20~90 min	45 min	Adjustable
12	De-icing activation temperature	-15~1°C	-3°C	Adjustable
13	Maximum de-icing duration	5~20 min	8 min	Adjustable
14	De-icing deactivation temperature	1~40°C	20°C	Adjustable
15	Reserved - Do not adjust			Reserved
16	Reserved - Do not adjust			Reserved
17	Expansive valve action period	20~90s	45s	Adjustable
18	Reserved - Do not adjust			Reserved
19	Reserved - Do not adjust			Reserved
20	Reserved - Do not adjust			Reserved
21	The mini opening for the electrical expansive valve	50~150	80	Adjustable
22	Reserved - Do not adjust			Reserved
23	Reserved - Do not adjust			Reserved
24	Reserved - Do not adjust			Reserved
25	Reserved - Do not adjust			Reserved
26	Reserved - Do not adjust			Reserved
27	Reserved - Do not adjust			Reserved
28**	Filtration pump servo-control mode	0 ~ 1	0	Adjustable
29	Max water outlet temp set in heating mode	25~40°C	40	Adjustable

* Parameter 01 allows you to change the deviation degree interval from the requested temperature so that the heat pump starts again.

Example : If the value of parameter 01 is 3°C, after reaching the required temperature (eg 27°C), the heat pump will restart when the pool temperature drops to 24°C (27 - 3).

5. Operation

5.1 Operation

Conditions of use

For the heat pump to operate normally, the ambient air temperature must be between -20°C and 43°C.

Recommendations prior to start-up

Before activating the heat pump, please:

- √ Check that the unit is firmly secured and stable.
- √ Check that the gauge indicates a pressure greater than 80 psi.
- √ Check that the electrical wiring is properly connected to the terminals.
- √ Check the earthing.
- √ Check that the hydraulic connections are tight and that there is no leakage of water.
- √ Check that the water is circulating correctly in the heat pump and that the flow rate is adequate.
- √ Remove any unnecessary object or tool from around the unit.

Operation

1. Activate the unit's power supply protection (differential switch and circuit-breaker).
2. Activate the circulating pump if it is not servo-controlled.
3. Check the By-Pass opening and the control valves.
4. Activate the heat pump by pressing once on 
5. Adjust the remote control clock (Section 4.3)
6. Select the required temperature by using one of the remote control's modes (Section 4.1)
7. The heat pump's compressor will start up after a few moments.

All you have to do now is wait until the required temperature is reached.

WARNING: Under normal conditions, a suitable heat pump can heat the water in a swimming pool by 1°C to 2°C per day. It is therefore quite normal to not feel any temperature difference in the system when the heat pump is working.

A heated pool must be covered to avoid any loss of heat.

5.2 Using the pressure gauge

The gauge is for monitoring the pressure of the refrigerant contained in the heat pump.

The values it indicates can vary considerably, depending on the climate, temperature and atmospheric pressure.

When the heat pump is in operation:

The gauge's needle indicates the refrigerant pressure.

Mean operating range between 250 and 400 PSI, depending on the ambient temperature and atmospheric pressure.

When the heat pump is shut down:

The needle indicates the same value as the ambient temperature (within a few degrees) and the corresponding atmospheric pressure (between 150 and 350 PSI maximum).

If left unused for a long period of time:

Check the pressure gauge before starting up the heat pump. It must indicate at least 80 PSI.

If the pressure goes down too much, the heat pump will display an error message and automatically go into 'safe' mode.

This means that there has been a leakage of refrigerant and that you must call a qualified technician to replace it.

This means that there has been a leakage of refrigerant and that you must call a qualified technician to identify why the leak occurred, rectify the cause and replace the gas.

6. Maintenance and servicing

6.1 Maintenance and servicing



WARNING: Before undertaking maintenance work on the unit, ensure that you have disconnected the electrical power supply.

Cleaning

The heat pump's casing must be cleaned with a damp cloth. The use of detergents or other household products could damage the surface of the casing and effect its properties.

The evaporator at the rear of the heat pump must be carefully cleaned with a vacuum cleaner and soft brush attachment.

Annual maintenance

The following operations must be undertaken by a qualified person at least once a year.

- ✓ Carry out safety checks.
- ✓ Check the integrity of the electrical wiring.
- ✓ Check the earthing connections.
- ✓ Monitor the state of the pressure gauge and the presence of refrigerant.
- ✓ It would be wise for heat pumps that are used on Ponds and non-Chemically treated Hot Tub users to flush out the titanium heat exchanger, every few months, as Bio-Film will build up here all depending on bather and fish loading. **N.B. Be careful of the water flow switch and anything electrical when doing this.**

6.2 Winter storage

In the winter months when the ambient temperature is lower than 3°C, a shut-down heat pump must be winterised to avoid any frost damage.

Your heat pump is designed to operate in rainy weather conditions and withstand frost using a specially created anti-frost technology. However it is not recommended to leave it outside for long periods of time (e.g. over winter) whilst connected to water without flow. After draining down the pool for the winter, the heat pump unit being **"FREE"** from any trapped water that may freeze. Store the heat pump in a dry place "IF" applicable or winterise and cover.

Winterising in 4 steps



Step 1
Disconnect the heat pump from the power supply.

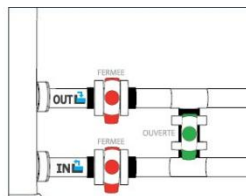

Step 2
Open the By-Pass valve. Close the inlet and outlet valves.

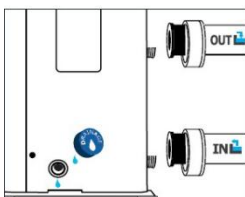

Step 3
Unscrew the drain plug and water pipes in order to drain any water from the heat pump.

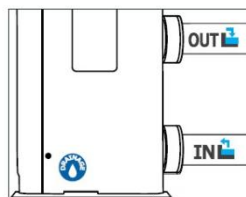

Step 4
Screw back the drain plug and pipes or block them with rags so as to prevent any foreign bodies from getting into the circuit. Finally, protect the pump with its winter storage cover.

7. Repairs



WARNING: Under normal conditions, a suitable heat pump can heat the water in a swimming pool by 1°C to 2°C per day. It is therefore quite normal to not feel any temperature difference in the system when the heat pump is working.

A heated pool must be covered to avoid any loss of heat.

7.1 Breakdowns and faults

In the event of a problem, the heat pump's screen displays a fault symbol ERROR instead of temperature indications. Please consult the table BELOW to find the possible causes of a fault and the actions to be taken.

Fault code examples:



7. Repairs

7.2 List of faults

Code	Fault	Possible causes	Action
03	Flow sensor malfunction	Insufficient water in heat exchanger	Check your water circuit operation and the opening of the By-Pass valves
		Sensor disconnected or defective	Reconnect or replace sensor
04	Antifreeze protection	Protection activated when the ambient temperature is too low and the unit is on standby	No intervention is necessary
05	High pressure protection	Insufficient water flow	Check water pump operation and openings of By-Pass inlet/outlet valves
		Excess refrigerant gas	Readjust the refrigerant volume
		Defective 4-way valve	Replace the 4-way valve
		High pressure switch disconnected or defective	Reconnect or replace high pressure switch
06	Low pressure protection	Insufficient refrigerant gas	Readjust the refrigerant volume
		Defective 4-way valve	Replace valve
		Low pressure switch disconnected or defective	Reconnect or replace low pressure switch
09	Connection problem between PCB and wired remote control	Bad connection	Check wiring connections between remote control and PCB
		Defective wired remote control	Replace remote control
		Defective PCB	Replace PCB
10	Connection problem between PCB and inverter module	Bad connection	Check wiring connections between PCB and inverter module
		Defective inverter module	Replace inverter module
		Defective PCB	Replace PCB
12	Vented air temperature too high	Insufficient refrigerant gas	Readjust the refrigerant volume
13	Vented air temperature too low	Ambient temperature too low	Check the ambient temperature
		Sensor disconnected or defective	Reconnect or replace sensor
15	Water intake temperature sensor malfunction	Sensor disconnected or defective	Reconnect or replace sensor
16	Outside coil temperature error	Sensor disconnected or defective	Reconnect or replace sensor
18	Vented temperature error	Sensor disconnected or defective	Reconnect or replace sensor
20	Inverter module protection	See chapter Appendices	
21	Ambient temperature error	Sensor disconnected or defective	Reconnect or replace sensor
23	Water temperature at outlet too low for cooling mode	Insufficient water flow	Check water pump operation and openings of By-Pass inlet/outlet valves
27	Water outlet error	Sensor disconnected or defective	Reconnect or replace sensor
29	Backed temperature error	Sensor disconnected or defective	Reconnect or replace sensor
32	Outlet temperature too high for heating mode protection	Insufficient water flow	Check water pump operation and openings of By-Pass inlet/outlet valves
33	Coil temp too high (higher than 60°C) for cooling mode protection	Refrigerant overcharged	Readjust the refrigerant volume
		Fan motor doesn't work or air outlet blocked	Check the fan is working properly and the air inlet is unobstructed
34	Too great a difference between the inlet water temperature and the outlet water temperature	Insufficient water flow	Check the good circulation of water in the heat pump, and the opening of the inlet / outlet valves of the By Pass
		Sensor disconnected or defective	Reconnect or replace sensor
42	Inside coil temperature error	Sensor disconnected or defective	Reconnect or replace sensor
46	DC fan motor malfunction	Bad wire connection	Reconnect the fan
		Fan motor is defective	Replace the fan motor

8. Wiring diagram Model: Crystal Vertical 120/200

